

KINTEK



SONDER-WERKZEUGHALTER



SPECIAL TOOLHOLDERS



СПЕЦИАЛЬНЫЕ РЕЗЦЕДЕРЖАТЕЛИ



PORTEOUTILS SPECIAUX



PORTAUTENSILI SPECIALI



专用刀柄

MAZAK NEXUS



KINTEK

VIA GORETTA 88/G - 10072 MAPPANO
FRAZIONE DI CASELLE (TO) - ITALIA
tel. +39.011.9968065 fax +39.011.9965662
<http://www.kintek.it> e-mail: Info@kintek.it

MAZAK NEXUS

SQT100/150

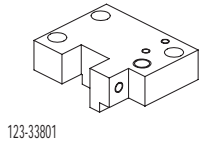

123-33801

Face and O.D. cutting holder

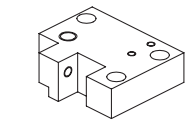

123-33802

Face and O.D. cutting holder

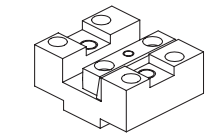

122-13801

Face and I.D. cutting holder



Qualified tool
20x20 mm

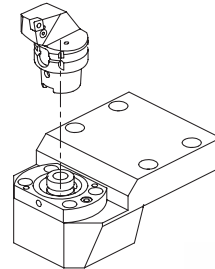

121-23803

Face and O.D. cutting holder

HSK 40 A+C



CONNECTION

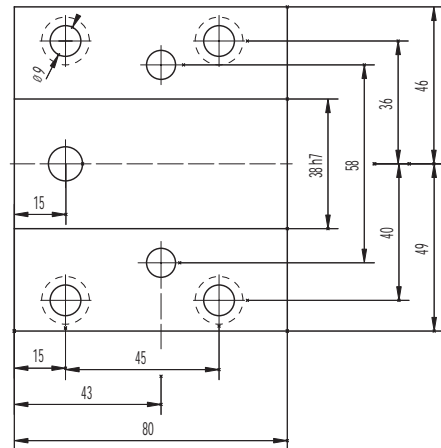

ACCESSORIES

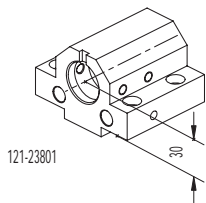

121-23801

Boring bar holder

Ø32 mm

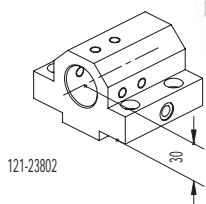

121-23802

Toolholder for insert drill with internal coolant

Ø32 mm

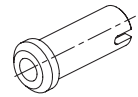

Drill socket
114-33216 <MT2>



Boring bar sleeve
165-63241 (Ø8 mm)
165-63242 (Ø10 mm)
165-63243 (Ø12 mm)
165-63244 (Ø16 mm)

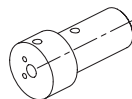

Boring bar sleeve
165-63245 (Ø20 mm)
165-63246 (Ø25 mm)

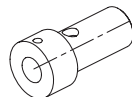

Throw-away drill socket
165-63247 (Ø20 mm)
165-63248 (Ø25 mm)

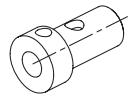

MAZAK NEXUS

QTN200/250

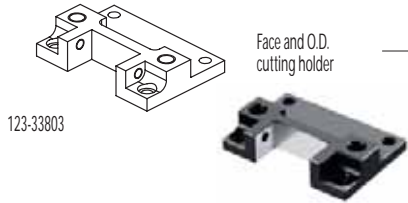

Face and O.D. cutting holder

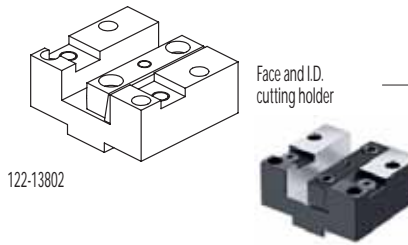

Face and I.D. cutting holder

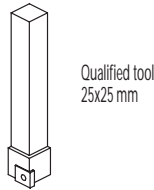

CONNECTION

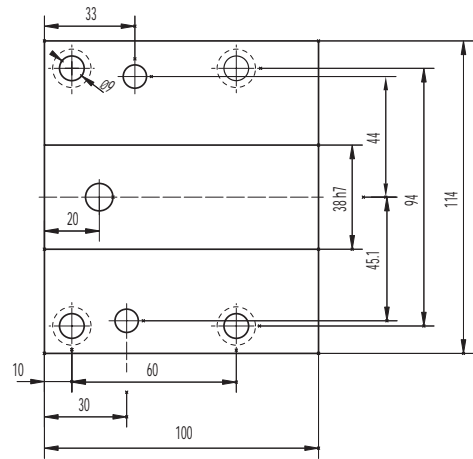

ACCESSORIES

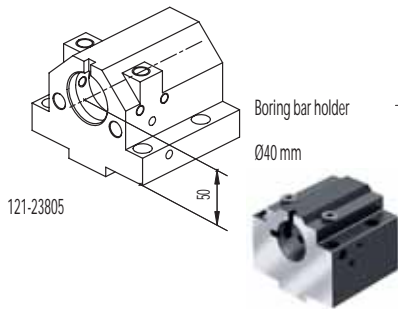

Boring bar holder
Ø40 mm

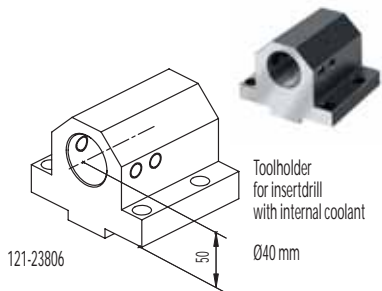

Toolholder for insertdrill with internal coolant
Ø40 mm

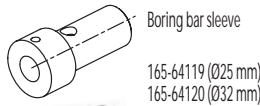
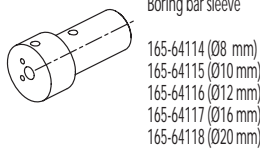

MAZAK SQT MAZAK QTN (VDI40)

SQT 15, SQT 18 M / MS - 12 Stations
 SQT 200, SQT 250 M / MS - 12 Stations
 QTN 200, QTN 250 M / MS / MY / MSY - 12 Stations

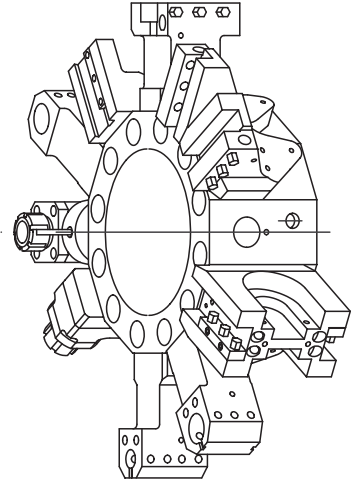
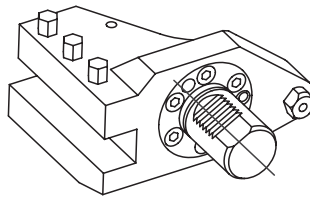
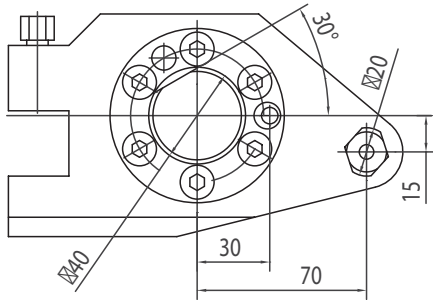

Qualified tool
25x25 mm

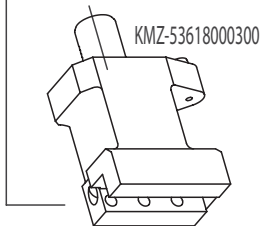
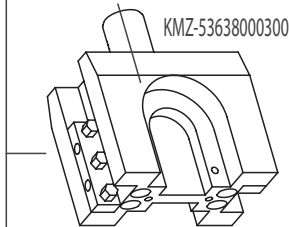
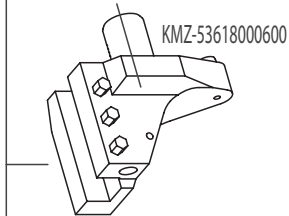
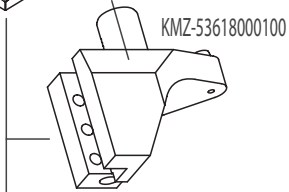
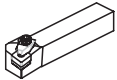

ACCESSORIES

Drill socket

- 114-34015 <MT1>
- 114-34016 <MT2>
- 114-34017 <MT3>

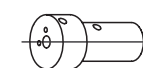
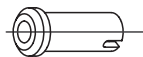

Boring bar sleeve

- 165-64114 (Ø8 mm)
- 165-64115 (Ø10 mm)
- 165-64116 (Ø12 mm)
- 165-64117 (Ø16 mm)
- 165-64118 (Ø20 mm)

Boring bar sleeve

- 165-64119 (Ø25 mm)
- 165-64120 (Ø32 mm)

Throw-away drill socket

- 165-64121 (Ø20 mm)
- 165-64122 (Ø25 mm)
- 165-64123 (Ø32 mm)

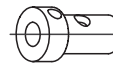

Cut-off tool
32 mm

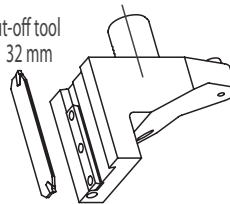

KMZ-53618000400

KMZ-53208005100

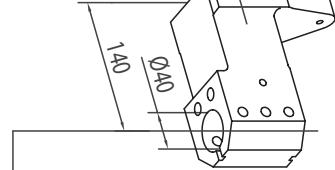

KMZ-53638000400

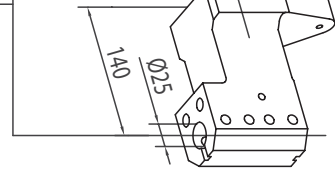

KMZ-53208005200

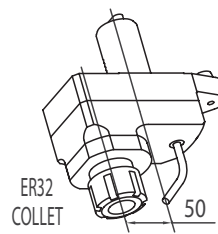
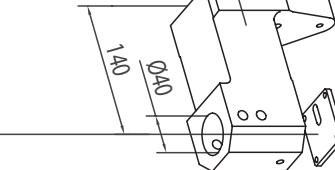

ER32 COLLET
KMZ-40A0LE32E01

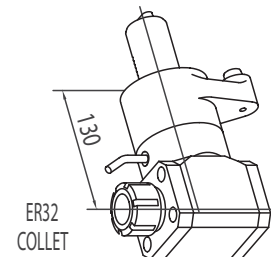

ER32 COLLET
KMZ-40A9LE32E01

